

The logo for ALETROON features the word "ALETROON" in a bold, dark blue, sans-serif font. The letter "O" is stylized as a large blue circle with a smaller orange circle inside it, and a small orange dot is positioned above the top-right curve of the blue circle. The background is white with dark blue curved borders on the left and right sides.

ALETROON

O PODER DAS PONTAS.



Há mais de cinco décadas, iniciamos nossa jornada com a missão de transformar o mercado de exaustores eletrostáticos. Reconhecendo a necessidade de soluções inovadoras para melhorar a qualidade do ar industrial, nossos fundadores investiram em pesquisa e desenvolvimento, resultando em tecnologias de ponta que revolucionaram o setor.

Ao longo dos anos, enfrentamos desafios, mas nunca perdemos de vista nosso objetivo: fornecer sistemas de exaustores eletrostáticos que não apenas atendam, mas superem as expectativas dos clientes. Nossa reputação cresceu como sinônimo de qualidade e confiabilidade. Hoje, orgulhamo-nos de nosso legado de excelência, mas não nos acomodamos. Continuamos comprometidos em evoluir e enfrentar os desafios futuros, mantendo viva a chama da inovação. Com tecnologia de ponta e suporte técnico especializado, estamos prontos para continuar a moldar o futuro do mercado, garantindo um ambiente mais limpo e saudável para todos.

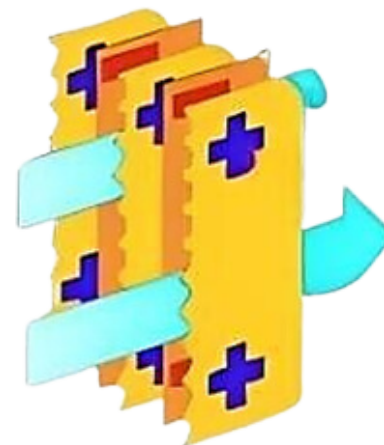

Lâminas com
tecnologia
Hayashi



NOSSO PROPÓSITO



Nosso propósito é cuidar da qualidade do ar



Em sistemas de Exaustão Para Cozinhas Profissionais.

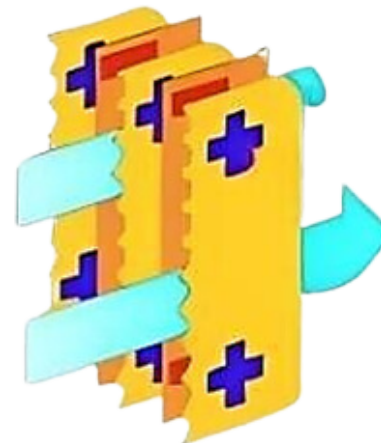

Lâminas com
tecnologia
Hayashi



Em Unidade de tratamento de Ar para ambientes corporativos.

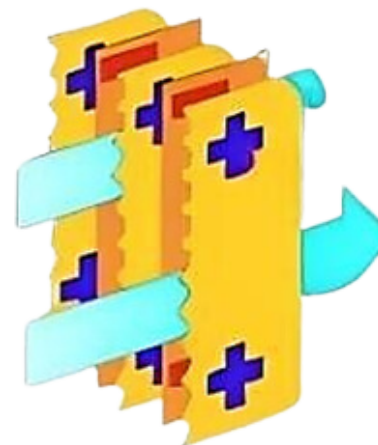

Lâminas com
tecnologia
Hayashi



E em Sistema Anti Poluição Industrial.

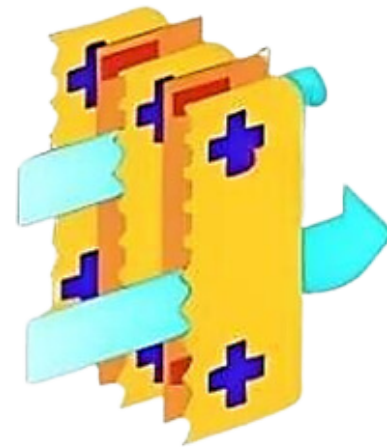

Lâminas com
tecnologia
Hayashi



NOSSO ESCRITÓRIO E A NOSSA FÁBRICA

ALETRON

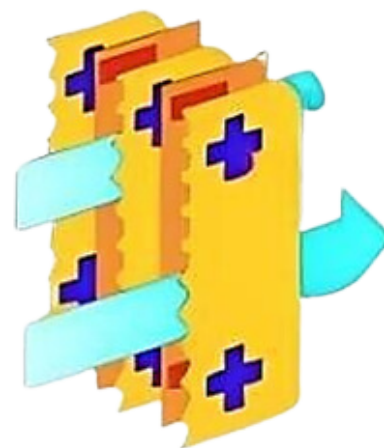
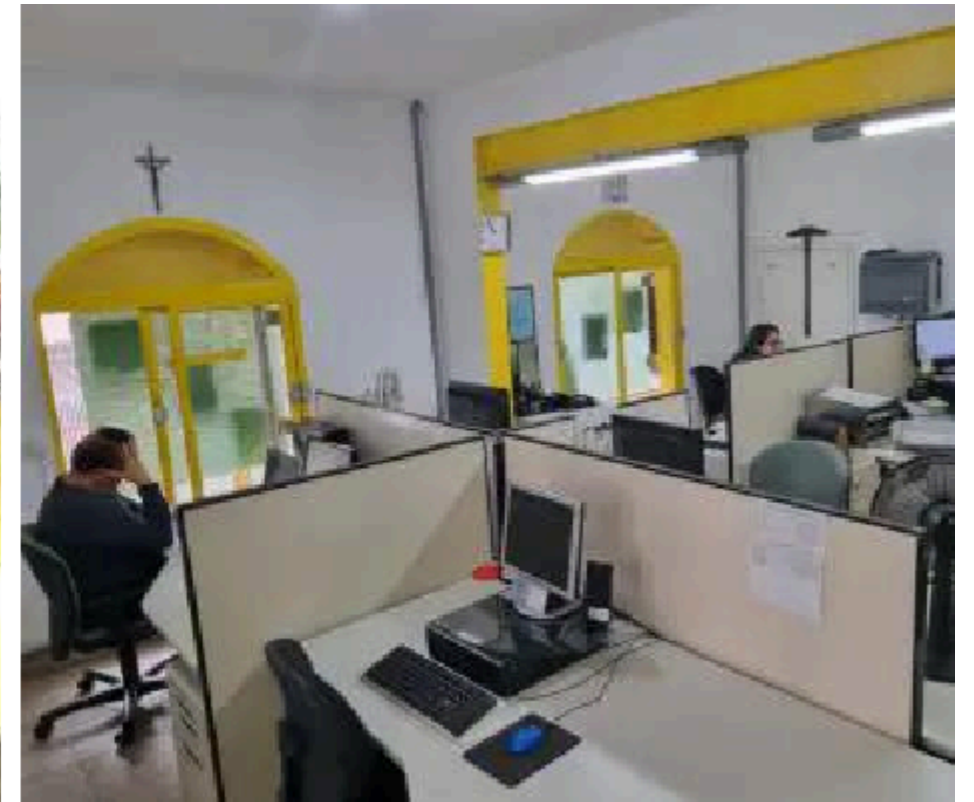

Lâminas com
tecnologia
Hayashi

ALETRON

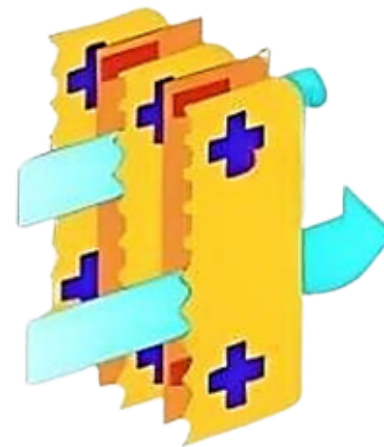

Lâminas com
tecnologia
Hayashi



ARÉA DE ATUAÇÃO

ALETRON

- Varanda Gourmet – Coifa de Churrasqueira
- Sistema de Exaustão e Ventilação para Cozinhas Industriais
- Sistema de Exaustão e Ventilação para Condomínios Comerciais
- Sistema de Exaustão e Ventilação para Ambientes de Saúde
- Sistema de Exaustão e Ventilação para Residências
- Exaustores para Barcos, Navios e Balsas
- Precipitador Hidro Lavador de Gases
- Forno Combinado
- Segurança contra incêndio em Cozinhas Profissionais
- Exaustores Profissionais
- Exaustores Lavadores
- Captor de Bancada
- Exaustão para Restaurantes Containers
- Exaustão para Quiosques
- Food Truck
- Coifa com Lâmpada UV-C ou Germicida
- UTA Unidade de Tratamento de Ar
-

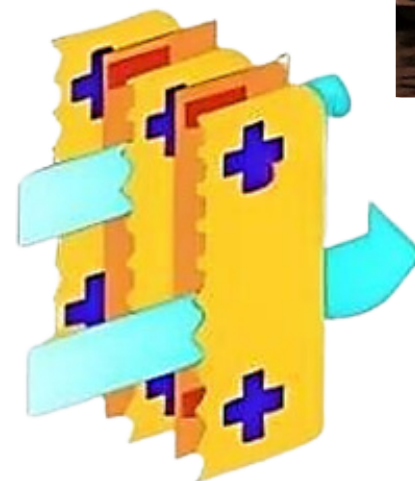
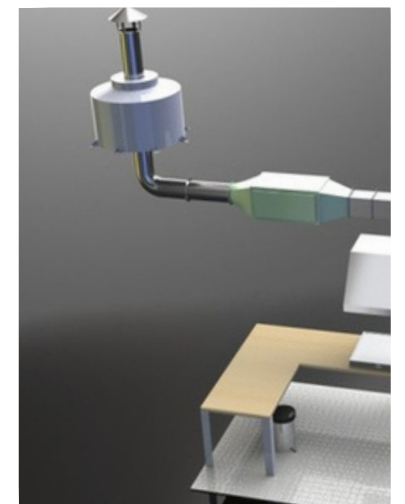
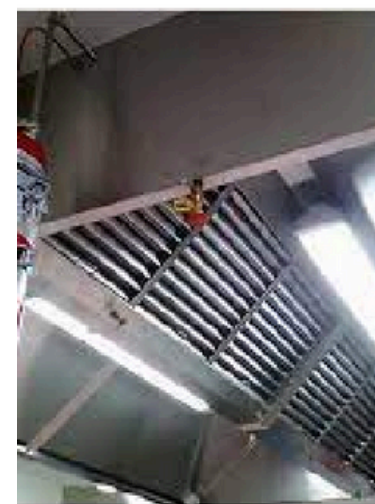
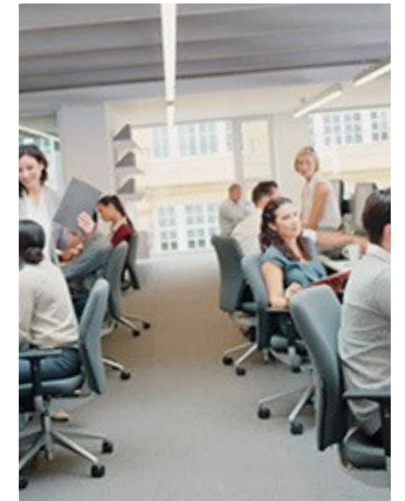

Lâminas com
tecnologia
Hayashi



NOSSOS PRODUTOS E SERVIÇOS ATENDEM AS NORMAS E LEGISLAÇÃO DAS SEGUINTE ORGANIZAÇÕES

ALETRON



- ASHRAE – American Society of Heating, Refrigerating and Air – Conditioning Engineers, Inc.
- ABRAVA – Associação Brasileira de Refrigeração, Ar Condicionado, Ventilação e Aquecimento.
- SINDRATAR – Sindicato das Indústrias de Refrigeração, Aquecimento e Treinamento de Ar Condicionado.
- SBCC – Sociedade Brasileira de Controle de Contaminação.
- SMACNA – Sheet Metal and Air Conditioning National Association
- ISPE – International Society for Pharmaceutical Engineering.

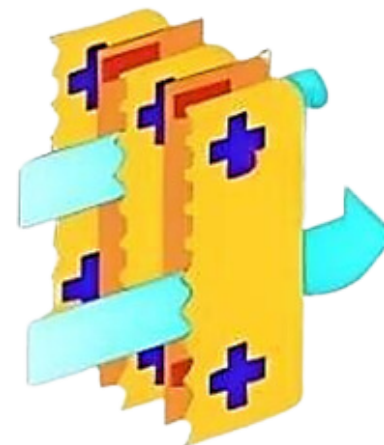

Lâminas com
tecnologia
Hayashi



CONHEÇA NOSSOS PRODUTOS

ALETRON

Gabinete de Precipitador Eletrostático ESP

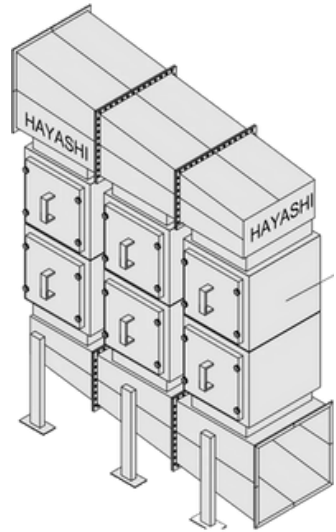

Filtro Eletrostático Ionizador ESP

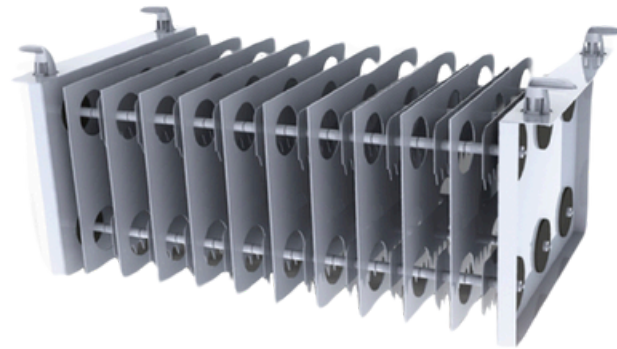

Coifa para Quiosque



Coifas sem duto Semi industriais

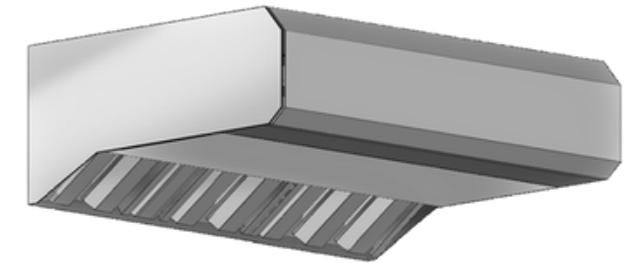

Captor de Bancada para Fritadeira e Bloco de Cocção



Coifa com filtro Eletrostático ESP sem Duto Horizontal



Coifa com filtro Eletrostática sem Duto Vertical



Coifa Lavadora

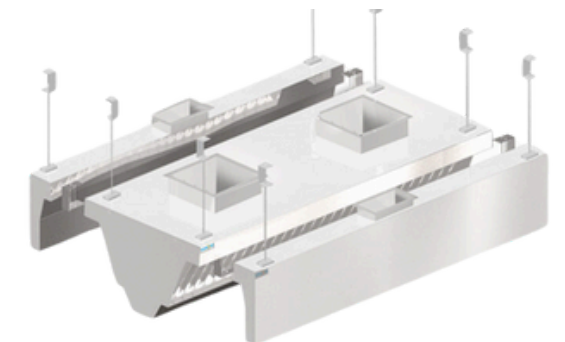

[Clique aqui e saiba mais!](#)



APE – Equipamento de Esterilização de Ar Portátil



Captor tipo Fresta ou Capela

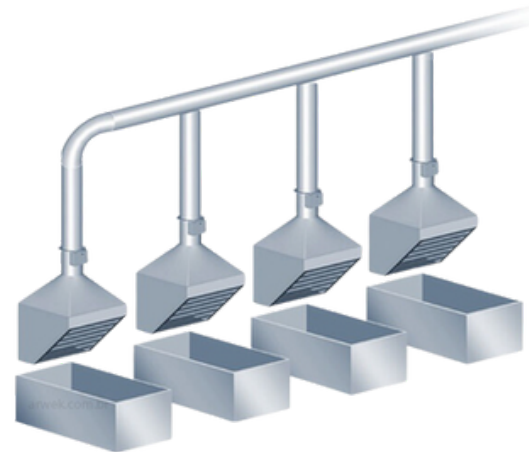

Cúpula de Exaustão para Forno de Ciclo Combinado

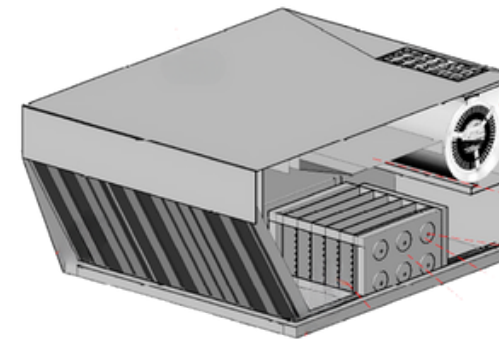

Separador Nevoa de Óleo Solúvel com Filtro Eletrostático ESP



Precipitador Hidro Lavador de Gases

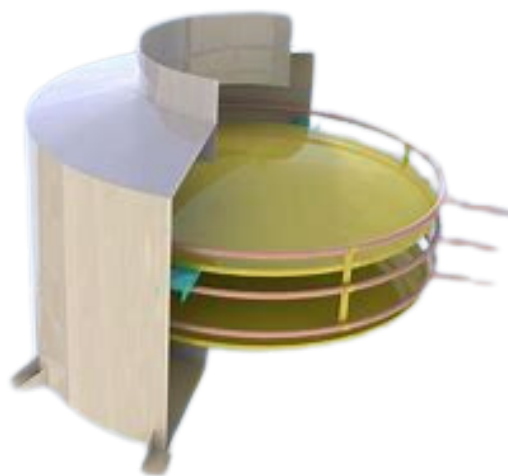

UDH – Unidade de Descontaminação

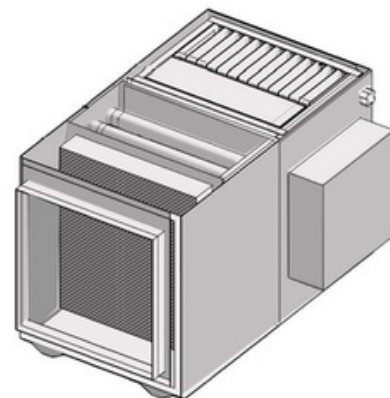

Unidade Ionizadora e Ozonizador de Centrais de Ar Condicionado

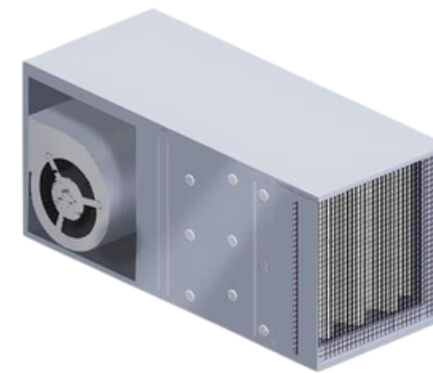

UTA – Unidade de Tratamento de Ar

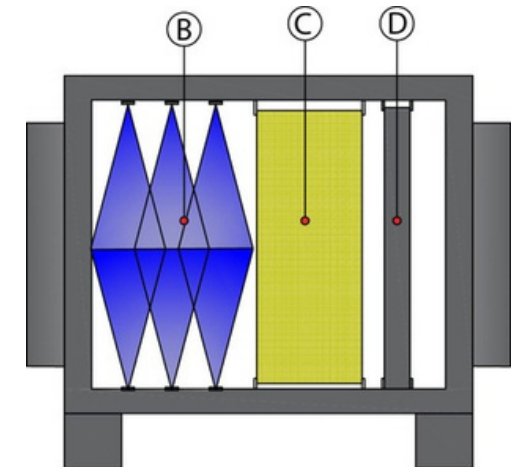

[Clique aqui e saiba mais!](#)

ALETRON

Coifa com Lâmpada UV ou Germicida

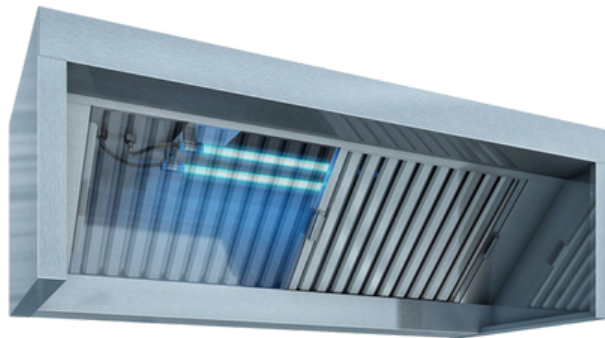

Coifas Convencionais

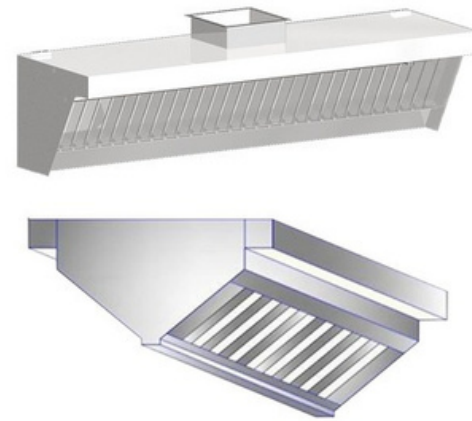

Tecnologia de exaustão e depuração aplicada a geradores de energia

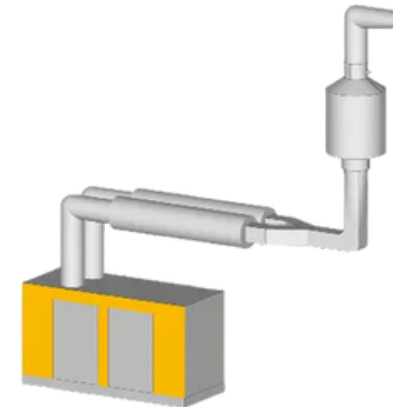

Coifas Eletrostáticas



Coifa para Contêiner (food box)



Coifa para Food Truck

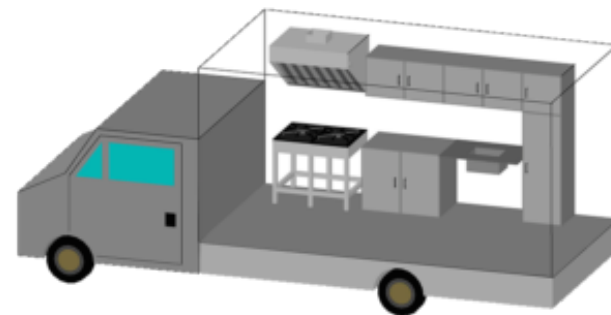

Sistemas de exaustão para churrasqueiras em edificações com múltiplos pavimentos

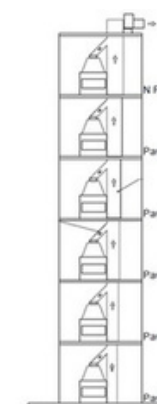

Coifas eletrostáticas residenciais



[Clique aqui e saiba mais!](#)



REGIÕES ATENDIDAS



A ALETRON OFERECE PRODUTOS PARA TODO BRASIL.

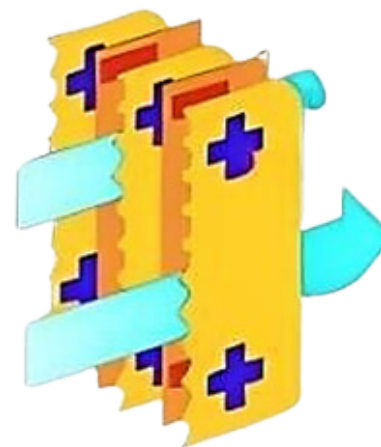

Lâminas com
tecnologia
Hayashi



Se interessou por algum produto?

Entre em contato conosco!
(11)932169701

Horário e Atendimento

Segunda à Sexta, das 8h00 às 17h00 Sábado das 8h00 às 12h00.

Se preferir, visite nosso Showroom

Rua João de Sousa Dias, 412- Campo Belo- São Paulo